

■ Features:

- With USB output port
- Anodized aluminum case provides durability& max heat dissipation
- The inverter is equipped with numerous protection features to guarantee
- Safe and trouble-free operation
- DC cigarette lighter accessory plug and heavy-duty cable clamps for high-output
- Automatic restart function
- Two LED indicators on the front panel shows the working and failure state
- Remote control function optional
- Digital display the battery voltage& loading power
- 100% real power, high surge power
- Germany technology, made in china, 1.5 years' warranty

■ Specification:

MODEL		NM2K-112	NM2K-124	NM2K-148	NM2K-212	NM2K-224	NM2K-248
Output	AC Voltage	100/110/120VAC			220/230/240VAC		
	Rated Power	2000W					
	Surge Power	Load 120~150%(3min.);4000W (3sec;resistive)					
	Frequency	50/60Hz ±3Hz					
	AC Regulation	±5%			±10%		
	Waveform	Modified Sine Wave 					
	Standard Receptacles	USA/British/Franch/Schuko /UK/Australia/Universal etc. optional					
	LED Indicator	Green for power on, red for faulty status					
USB port	5V 2.1A						
Input	No Load Current Draw	≤1.80A	≤1.50A	≤1.20A	≤1.80A	≤1.50A	≤1.20A
	DC Voltage	12VDC	24VDC	48VDC	12VDC	24VDC	48VDC
	Voltage Range	10.5~15VDC	21~30VDC	42~60VDC	10.5~15VDC	21~30VDC	42~60VDC
	Efficiency(Typ.)	89%	91%	92%	91%	93%	94%
	Fuse	40A×8	20A×8	10A×8	40A×8	20A×8	10A×8
	Remote Control	Function(optional)					
LED Display Function	Voltage, Power (V, P) optional						
Protection	BAT. Low Alarm	10.5±0.5VDC	21±1.0VDC	42±2.0VDC	10.5±0.5VDC	21±1.0VDC	42±2.0VDC
	BAT. Low Shutdown	10±0.5VDC	20±1.0VDC	40±2.0VDC	10±0.5VDC	20±1.0VDC	40±2.0VDC
	Over Load	Shut down output voltage , restart to recover					
	Over Voltage	15.5±0.5VDC	31±1.0VDC	62±2.0VDC	15.5±0.5VDC	31±1.0VDC	62±2.0VDC
	Over Temperature	Shut down output voltage , recover automatically after temperature goes down					
	Output Short	Shut down output voltage , restart to recover					
	DC Input Reverse Polarity	By fuse					
	Earth Fault	Shut off o/p when the load has electrical leakage					
Soft Start	Yes, 3-5 Seconds						
Environment	Working Temp.	0~+50°C					
	Working Humidity	20~90%RH non-condensing					
	Storage Temp.& Humidity	-30~+70°C,10~95%RH					
Safety & EMC	Safety Standards	Certified UL 458(only for "GFCl" receptacles)			Certified EN 60950-1; 2006+A11: 2009+A1: 2010+A12: 2011+A2: 2013.		
	Isolation Resistance	I/P-O/P:100M Ohms/500VDC					
	EMI Conduction & Radiation	Certified FCC class A			Certified EN 62040-2:2006,EN61000-3-2; EN61000-3-3;		
	EMS Immunity	-----			Certified IEC61000-4-3, IEC61000-4-6		
	E-MARK	-----			Certified ECE RIO.05:2014		
Others	Dimension(L×W×H)	330×230×106mm					
	Packing	4kg;2pcs/9kg/0.049m³					
	Cooling	Load control fan or by thermal control fan					
	Application	Home and Office appliances, Portable Power Equipment, Vehicle,Yacht and Off-Gid Solar power systems....etc.					

Elizler Enerji

Adres: Mimar Sinan Mh 101. Cd Depocular Ve Yan Sanayiciler Sitesi D Blok No 4 Kapaklı Tekirdağ











Tel: 0282 6060818 - 0530 760 6438

 email : info@pantecsolar.com

 Website: www.pantecsolar.com

File Name:NS2K-spec 09/08/16

■ Socket Type:

										
A	B	C	D	E	F	G	H	I	J	K

■ Mechanical Drawings:

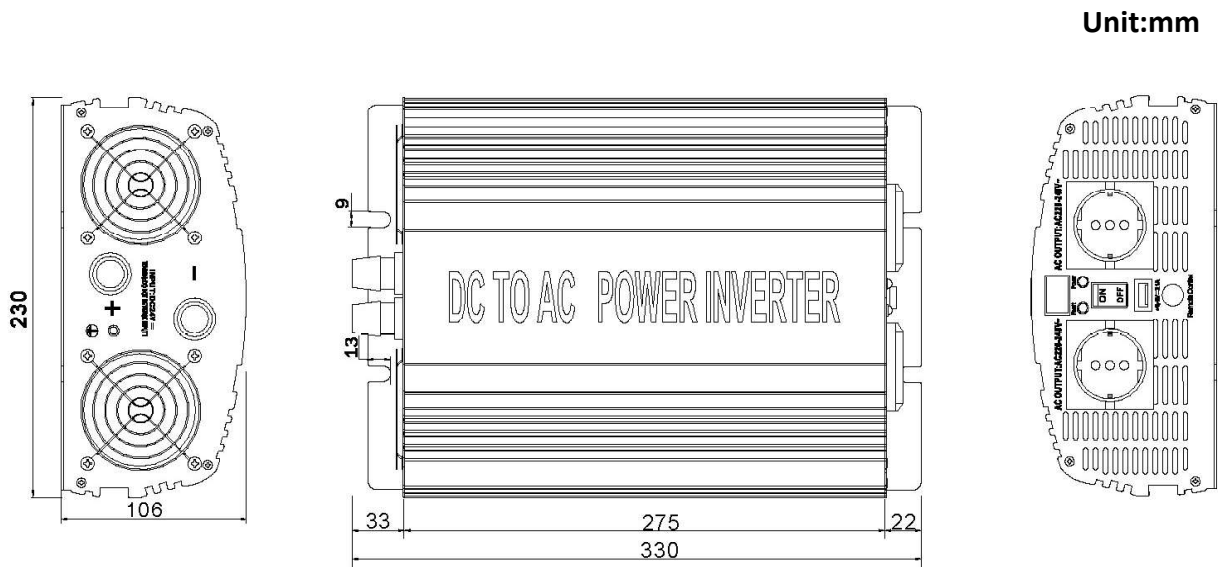

Elizler Enerji

Adres: Mimar Sinan Mh 101. Cd Depocular Ve Yan Sanayiciler Sitesi D Blok No 4 Kapaklı Tekirdağ

Tel: 0282 6060818 - 0530 760 6438

email : info@pantecsolar.com

Website: www.pantecsolar.com

File Name: NS2K-spec 09/08/16